

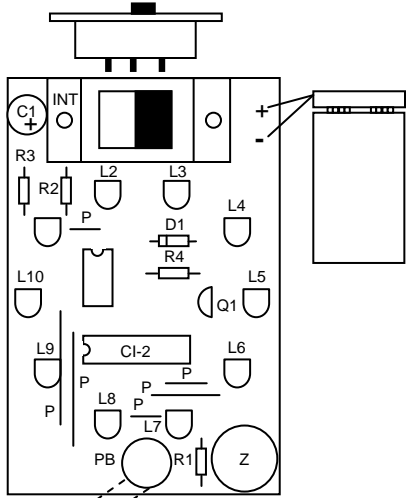

Interruptor

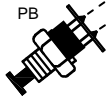

Bateria



Diodo led

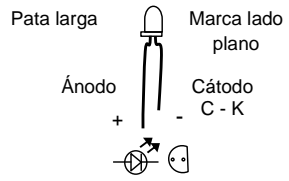

Puente

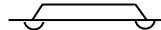

Unir con un alambre

Zumbador

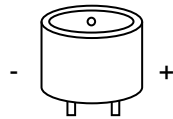

Circuito Integrado PIC12F629

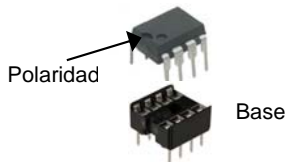

Electrolítico

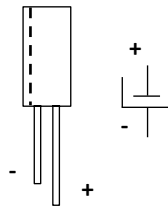

Diodo

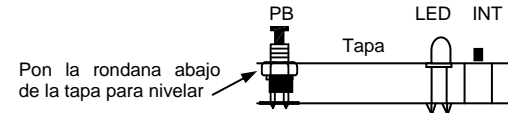
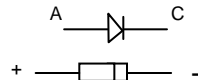

Pon la rondana abajo de la tapa para nivelar

Cuida que la altura de los leds sea igual que el interruptor de presión y el switch deslizable.

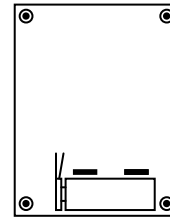

Bateria